

APPLICATION

Washdown inductive sensors monitor position of control valves during dairy-product processing

During manufacture of dairy products, raw milk travels between successive processes through stainless-steel pipework. Rotary-shaft control valves maintain process sequences correctly, ensuring that no cross-contamination occurs during CIP cleaning after each batch is completed. Robust washdown inductive sensors, mounted on existing rotary actuators, monitor control-valve status around the clock, providing real-time positional feedback to a plant-wide control system in a simple, cost-effective manner.

INDUSTRIES

Food and beverage, packaging, logistics, materials handling, pharmaceutical industry, industrial cleaning systems



Sorting conveyor for egg packaging



Brewery production equipment



Pharmaceutical industry



Automated laundry system

WASHDOWN INDUCTIVE SENSORS

ECOLAB APPROVED FOR HARSHTEST CLEANING PROCESSES

Washdown inductive sensors are certified to operate continuously and reliably in the harsh conditions of the food, beverage and pharmaceutical industries, ensuring uninterrupted production. Rated to **IP68** and **IP69K**, they are pressure resistant up to **80 bar**, **food safe and corrosion resistant**; additionally Full Inox – Series 700 are **Ecolab** certified.

KEY ADVANTAGES

- ✓ Corrosion resistant
- ✓ Food safe
- ✓ IP68/IP69K protection
- ✓  **IO-Link** interface
- ✓ Extremely rugged Full Inox types: one-piece stainless-steel housing, factor 1 on steel and aluminum
- ✓ Ecolab approved



PRODUCT OVERVIEW

		 IO-Link		
Housing size mm		M12	M18	M30
s _n mm	Classics	2	–	–
	Full Inox	6 ... 10	10 ... 20	20 ... 40

ACCESSORIES

Go to page 298 to see all the accessories

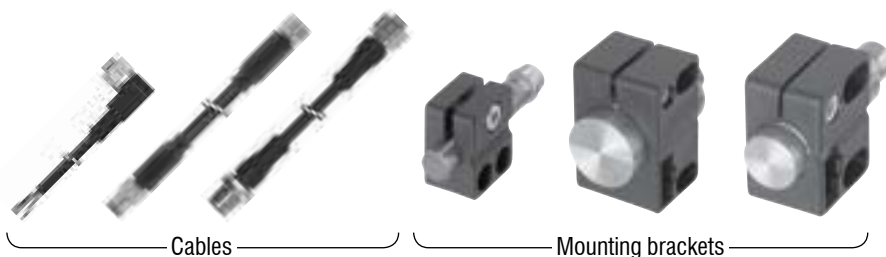

Cables

Mounting brackets

INDUCTIVE SENSORS WASHDOWN



FAMILY	OPERATING DISTANCE (mm)	HOUSING SIZE (mm)	HOUSING LENGTH (mm)	HOUSING MATERIAL
CLASSICS SERIES 600	2	M12	60	Stainless steel V4A

COMMON FEATURES

Supply Voltage range	10 ... 30 VDC
Output	PNP NO*

* Other types available: PNP NC, NPN NC

OUTPUT

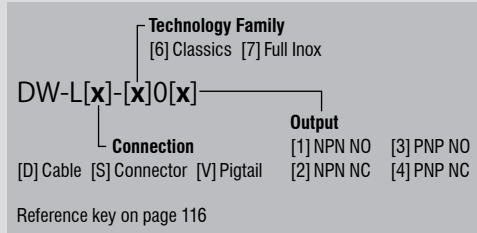

ACCESSORIES

- A** Group A: M8 3-pin
Sub-group: Field attachable connectors
Sub-group: Distribution boxes
- B** Group B: M8 4-pin
- C** Group C: M12 4-pin
Sub-group: Field attachable connectors
Sub-group: Distribution boxes
- D** Group D: M12 AC/DC 3-pin
- E** Group E: Universal mounting brackets
Sub-group: Mechanical stops
- F** Group F: Photoelectric mounting brackets
- G** Group G: Photoelectric reflectors
- H** Group H: Sensor tester

Go to page 298 for details

CABLES
Cable lengths available:
2 m, 5 m, 10 m
other customised lengths possible

FULL INOX – SERIES 700	6	M12	60	Stainless steel V4A
	10	M12	60	Stainless steel V4A
	6	M12	66.5	Stainless steel V4A
	10	M12	66.5	Stainless steel V4A
	10	M18	63.5	Stainless steel V4A
	20	M18	63.5	Stainless steel V4A
	10	M18	66.5	Stainless steel V4A
	20	M18	66.5	Stainless steel V4A
	20	M30	63.5	Stainless steel V4A
	40	M30	63.5	Stainless steel V4A
	20	M30	66.5	Stainless steel V4A
	40	M30	66.5	Stainless steel V4A
20	M30	66.5	Stainless steel V4A	



CABLE	CONNECTOR	IO-Link	SWITCHING FREQUENCY (Hz)	MOUNTING		AMBIENT TEMPERATURE	DEGREE OF PROTECTION	PART REFERENCE*	ACCESSORIES (SEE PAGE 114)
				EMB.	NON-EMB.				
	M12	IO-Link	1,700	Embed.		-25 ... +120°C	IP68 / IP69K	DW-LS-603-M12	C E H
	M12	IO-Link	600	Embed.		-25 ... +85°C	IP68 / IP69K	DW-LS-703-M12	C E H
	M12	IO-Link	400	Non-embed.		-25 ... +85°C	IP68 / IP69K	DW-LS-713-M12	C E H
Teflon		IO-Link	600	Embed.		-25 ... +85°C	IP68 / IP69K	DW-LD-703-M12	E H
Teflon		IO-Link	400	Non-embed.		-25 ... +85°C	IP68 / IP69K	DW-LD-713-M12	E H
	M12	IO-Link	200	Embed.		-25 ... +85°C	IP68 / IP69K	DW-LS-703-M18-002	C E H
	M12	IO-Link	200	Non-embed.		-25 ... +85°C	IP68 / IP69K	DW-LS-713-M18-002	C E H
Teflon		IO-Link	200	Embed.		-25 ... +85°C	IP68 / IP69K	DW-LD-703-M18	E H
Teflon		IO-Link	200	Non-embed.		-25 ... +85°C	IP68 / IP69K	DW-LD-713-M18	E H
	M12	IO-Link	125	Embed.		-25 ... +85°C	IP68 / IP69K	DW-LS-703-M30-002	C E H
	M12	IO-Link	90	Non-embed.		-25 ... +85°C	IP68 / IP69K	DW-LS-713-M30-002	C E H
Teflon		IO-Link	125	Embed.		-25 ... +85°C	IP68 / IP69K	DW-LD-703-M30	E H
Teflon		IO-Link	90	Non-embed.		-25 ... +85°C	IP68 / IP69K	DW-LD-713-M30	E H
Teflon		IO-Link	100	Embed.		-25 ... +85°C	IP68 / IP69K	DW-LD-703-M30-220	E H



INDUCTIVE SENSORS REFERENCE KEY

DW-AD-503-M8E (-12X/-XXX)

INDUCTIVE SENSOR DW

SENSOR TYPE

Conventional	A
2-wire DC (NAMUR excepted)	D
High-temperature	H
Food and sea-water	L
Maritime	M

CONNECTION

Cable	D
Connector	S
Cable + connector	V

SERIES

500 / 520 (Extra Distance)	5
600 / 620 (Classics)	6
700 (Full Inox)	7
Embeddable / quasi-embeddable	0
Non-embeddable	1
Increased operating distance, (quasi-)embeddable	2
Increased operating distance, non-embeddable	3

OUTPUT

NPN NO	1
NPN NC	2
PNP NO	3
PNP NC	4
PNP changeover	A
NPN changeover	B

SHORT / SPECIAL EXECUTIONS

Series E (impervious)	E
Series 700P (all-metal and high-pressure resistant)	G

HOUSING SIZE

Threaded	
M4	4
M5	5
M8	8
M12	12
M18	18
M30	30
M50	50

Smooth	
Ø3 mm	3
Ø4 mm	4
Ø6.5 mm	65
Ø8 mm	80
5 × 5 mm	5
8 × 8 mm	8
20 × 32 mm	23
40 × 40 mm	44

HOUSING

Threaded cylindrical housing	M
Rectangular housing	C
Smooth cylindrical housing	0
High-pressure resistant	P

OUTPUT

2-wire DC	
NO / NAMUR	5
NC	6

2-wire AC/DC	
NO	7
NC	8
Analog	9

INTRODUCTION

TECHNOLOGY

Contrinex inductive devices work according to one of three different technologies. All involve the generation of an alternating magnetic field that emerges at the sensing face. The presence of a conductive, generally metallic, object influences this field in a way that can be detected and evaluated by built-in electronics. All Contrinex ASIC sensors are IO-Link enabled in PNP NO versions.

TECHNOLOGY FAMILIES

CLASSICS FAMILY

Conventional technology, engineered by Contrinex

The **Classics** family uses conventional inductive sensor technology, but with the benefit of a Contrinex ASIC (application specific integrated circuit). ASIC technology ensures reliability, stability and ease of commissioning, due to low variation. Sensors in this family achieve operating distances up to 2× the industry standard. All ASIC sensors in the **Classics** family are IO-Link enabled in PNP NO versions.

Classics sensors have a conventional oscillator and coil generating a high-frequency magnetic field that emerges at the sensing face. Any metallic object found in this field absorbs some of the energy, which is in turn detected and evaluated by built-in electronics (Fig. 1).

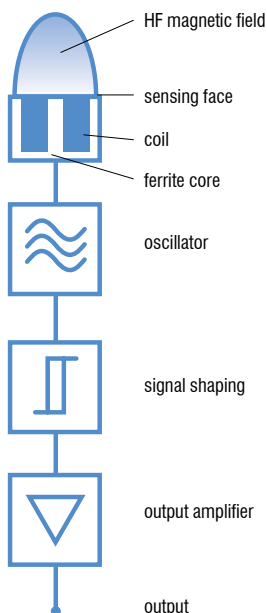

Fig. 1: Conventional inductive sensor technology, as used in the Classics family

Ferromagnetic metals (steel, nickel, cobalt) absorb the most energy. The achievable operating distances are therefore greatest with these metals. Non-ferromagnetic metals, such as aluminum, absorb less energy. As a result, operating distances are lower (approx. 25... 45% of those on steel).

The **Classics** technology family (series 600) includes devices from the ranges **Basic**, **Miniature**, **Extra Pressure**, **Extra Temperature**, **High Temperature**, **Washdown** and **2-Wire**.

EXTRA DISTANCE FAMILY

Increased stability for exceptionally long operating distance

The **Extra Distance** family is based on the **Condist®** oscillator developed by Contrinex. Sensors benefit from **up to 4× the standard** operating distance, keeping them out of harm's way in rugged, industrial environments. Sensor lifetime is therefore increased.

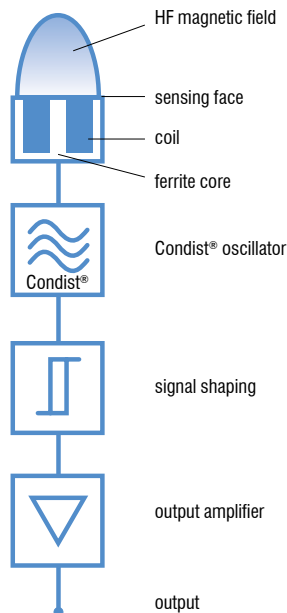
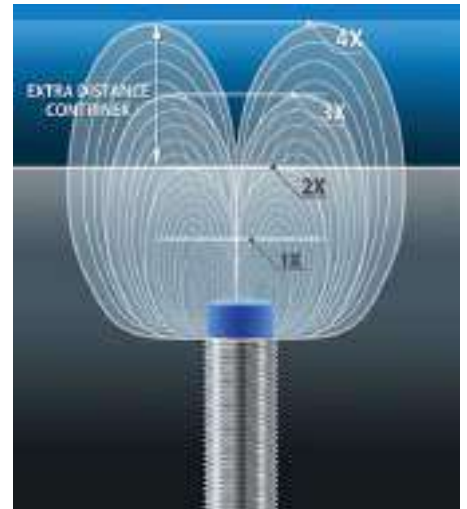

Fig. 2: Contrinex's Condist® inductive sensor technology, as used in the Extra Distance family



Like **Classics** family sensors, these also generate a high-frequency magnetic field that emerges at the sensing face (Fig. 2). Again, the resulting effect is that any metallic object entering the field absorbs energy from it.

However, the oscillator and the subsequent signal evaluation circuit are completely different, with the objective of achieving a significantly **better stability** with respect to environmental influences, in particular temperature. The most important contribution to this comes from the Contrinex **Condist®** oscillator.

Improved stability permits the switch point to be further away, leading to **long operating distances** on ferromagnetic metals (Fig. 3). Sensors with this technology also react particularly well to **narrow targets**, e.g. small screws, wires and foils.

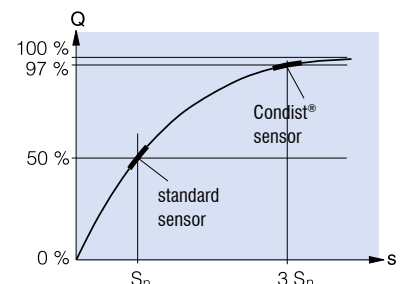

Fig. 3: Extra Distance family sensors have a longer operating distance, due to Condist® oscillator technology

Apart from the **Condist®** oscillator, all other assemblies are equivalent to the **Classics** family. Material

dependencies and other properties are also the same as for **Classics** family sensors.

Special attention has been paid to **meet the relevant standards as much as possible**, so that easy **interchangeability** with conventional devices is guaranteed. Great emphasis has been placed on very good EMC resistance and on perfect sealing against liquid penetration.

The **Extra Distance** technology family includes devices from the **Basic, Miniature, Extra Pressure, High Pressure** and **Analog Output** ranges. This technology is used in series 500 devices.

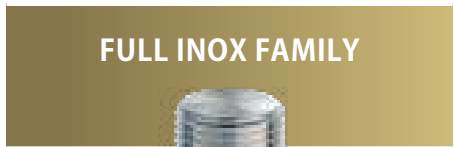

All-round stainless steel protection – practically indestructible

The **Full Inox** family is based on Contrinex's Condnet® technology. These one-piece stainless steel sensors are not only the most durable on the market, they also offer long operating distances on any conductive metal.

Full Inox sensors also function according to inductive technology. However, the coil which generates



the magnetic field is not part of the oscillator (Fig. 4). Instead, the field is generated by periodic, short transmitter current pulses, which flow through the coil (Fig. 5). This field induces a voltage in the target which, in turn, generates a current flow in it. When the **transmitter current pulse** is switched off, the current in the object dies away, causing a **voltage to be induced** in the transmitting coil (Fig. 6).

by the target's material. Operating distances are therefore identical on steel and aluminum. Only metals which are non-ferromagnetic and also have poor electrical conductivity give a reduced usable signal.

The **Full Inox** family includes devices from the **Basic, Miniature, Extreme, High Pressure, Wash-down, Weld-Immune, Chip-Immune, Maritime** and **Double-Sheet** ranges.

This voltage generates the signal required, and is in principle **independent of the field's energy loss**. Therein lies the fundamental advantage of this technology, since the field energy losses, which are evaluated in conventional sensors, are subject to a number of undesirable environmental and material influences. Condnet® technology allows the sensor, including its face, to be fully encapsulated in a protective, stainless steel housing, with the added security of long operating distances.

The coupling between the target and the coil is rather **like a transformer**, and is hence **temperature independent** and only **slightly influenced**

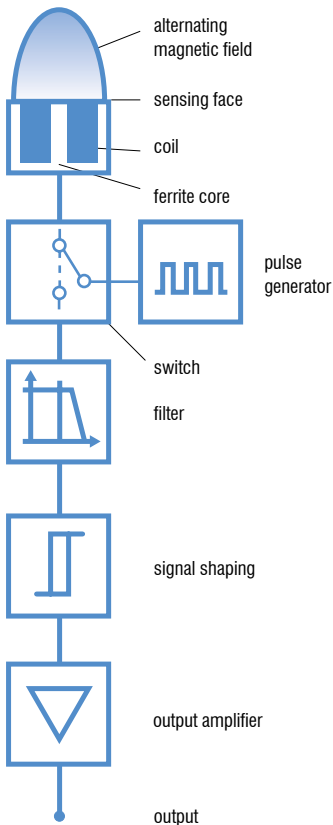

Fig. 4: Full Inox family sensors use Condnet® pulse generator technology instead of an oscillator

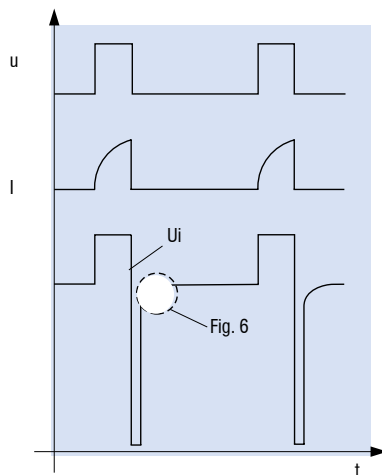

Fig. 5: Evolution of main signals

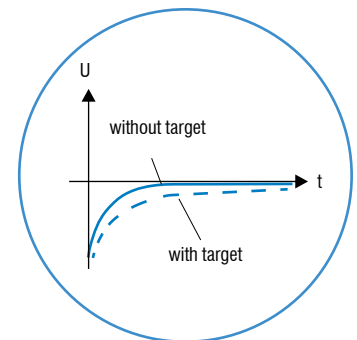

Fig. 6 (detail fig. 5): Effect of a target on the measured signal



Data monitoring

Switching state is monitored continuously. This not only monitors the signal itself, but also the state at 80% of the switching distance. One can therefore ensure that the sensor is not working at the limit of its specifications.

✓ ✓ ✓ ✓



Diagnosis

The operating state of the sensor is checked. In case of open circuit, under-voltage, LC oscillator failure or installation of the wrong sensor, information is provided directly through IO-Link to enable fast repair, maintenance and replacement.

✓ ✓ ✓ ✓



Detection counter

Detection events are counted. By registering the number of detections, it is possible to calculate the speed or number of parts. The counter can be reset by means of a unique IO-Link message.

✓ ✓ ✓



Temperature

The internal temperature of the sensor is measured continuously, which provides an indication about the ambient temperature in the application. Moreover, the maximum temperature measured is saved for diagnosis and preventive maintenance purposes.

✓ ✓ ✓

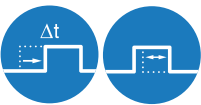

Switching timer

The timing of output switching can be configured. Depending on the needs of an application, output switching can be delayed or the duration stretched through programming.

✓ ✓ ✓ ✓



NO/NC selection

The output switching mode can be selected as NO or NC. A single sensor type is configurable for the various needs of an application. This helps reduce the number of different sensor types required in stock.

✓ ✓ ✓



Sensitivity and teach

The sensitivity of the sensor can be adjusted remotely by changing the threshold. Alternatively, the teach function can be used to adapt the threshold to the application. Calibrated sensing ranges ensure easy sensor replacement by uploading the existing sensitivity to the replacement sensor.

✓ ✓ ✓



Light-ON/Dark-ON selection

The output switching mode can be selected as Light-ON or Dark-ON. A single sensor type is configurable for the various needs of an application. This helps reduce the number of different sensor types required in stock.

✓



Sensor mode

Three different modes are selectable depending on the application needs: "Normal", "Fast" and "Fine". "Normal" mode is a good balance of speed and precision. In "Fast" mode, speed is higher and in "Fine" mode precision is higher.

✓ ✓ ✓



Sequence selection

For cross-talk immunity with through-beam sensors, up to nine different emitting sequences can be selected to pair the emitter with the receiver.

✓

* Functionalities may vary depending on series and sensor type

INTRODUCTION

CONTRINEX



Contrinex Headquarters, Switzerland

Contrinex is a leading manufacturer of sensors for factory automation. The Swiss company, headquartered in Corminboeuf near Fribourg (CH), has a unique and innovative range of products whose features far surpass those of standard sensors.

Since its foundation in 1972 by Peter Heimlicher, Dipl Ing ETH, Contrinex has grown from a one-man operation to a multinational group with over 580 employees worldwide. More than 13 subsidiaries cover the core markets in Europe, Asia, North and South America.

AT A GLANCE

- Technology leading manufacturer of inductive and photoelectric sensors as well as safety and RFID systems
- World market leader for miniature sensors, sensors with long operating distances and devices for particularly demanding operating conditions (all-metal, high-pressure and high-temperature resistant sensors)
- Represented in over 60 countries worldwide, headquarters in Switzerland
- 8,000 products

Technology leader for sensor intelligence and industrial RFID

INTELLIGENT SENSORS FOR THE 4TH INDUSTRIAL REVOLUTION: INDUSTRY 4.0

Fit for the future with IO-Link

Intelligent sensors are the fundamental building blocks of modern smart factories. They enable sensor-supported production resources (machines, robots, etc.) to configure, control, manage and optimize themselves. Precise, reliable sensor data is now more essential than ever.

Sensors from Contrinex, the leader in intelligent sensor technology, ensure excellent data quality. To communicate that data, all Contrinex inductive and photoelectric ASIC sensors will be equipped with IO-Link as standard. Customers use either the sensor's binary PNP output or its intelligent IO-Link interface. Both are available in one and the same device. Another advantage is the fact that, with Contrinex sensors, there is no extra charge for IO-Link. This makes them not only quick and simple to install, but also highly economic.

As the first standardized IO technology worldwide (IEC 61131-9) for communication with sensors and actuators, IO-Link is crucial to the 4th Industrial Revolution. By installing Contrinex ASIC sensors with IO-Link, users can make themselves fit for the future.

CUSTOMIZATION

Contrinex has extensive experience in product customization and brand labelling. Over the years, a team of specialists has worked with clients to design, develop and manufacture numerous unique products that meet individual specifications. Custom solutions can range from a very simple adaptation such as a special connector or cable to a new design with special signals, technical characteristics or a customized housing. The company is also equipped to meet branding requirements for product color, packaging, labelling and logos.

Production sites are available worldwide, so products can be manufactured for best availability and in quantities that suit the client's requirements. Quality is assured by vigorous lab testing, pre-shipment inspections and compliance with market standards. All production sites are open to quality audits by clients.

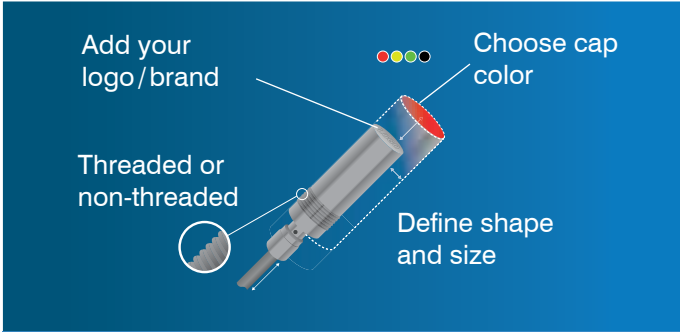

- ✓ Housing shape and size
- ✓ Cable length
- ✓ Embeddable / non-embeddable
- ✓ Threaded / non-threaded
- ✓ Selected technical characteristics

LIVE SENSOR DATA FOR IoT



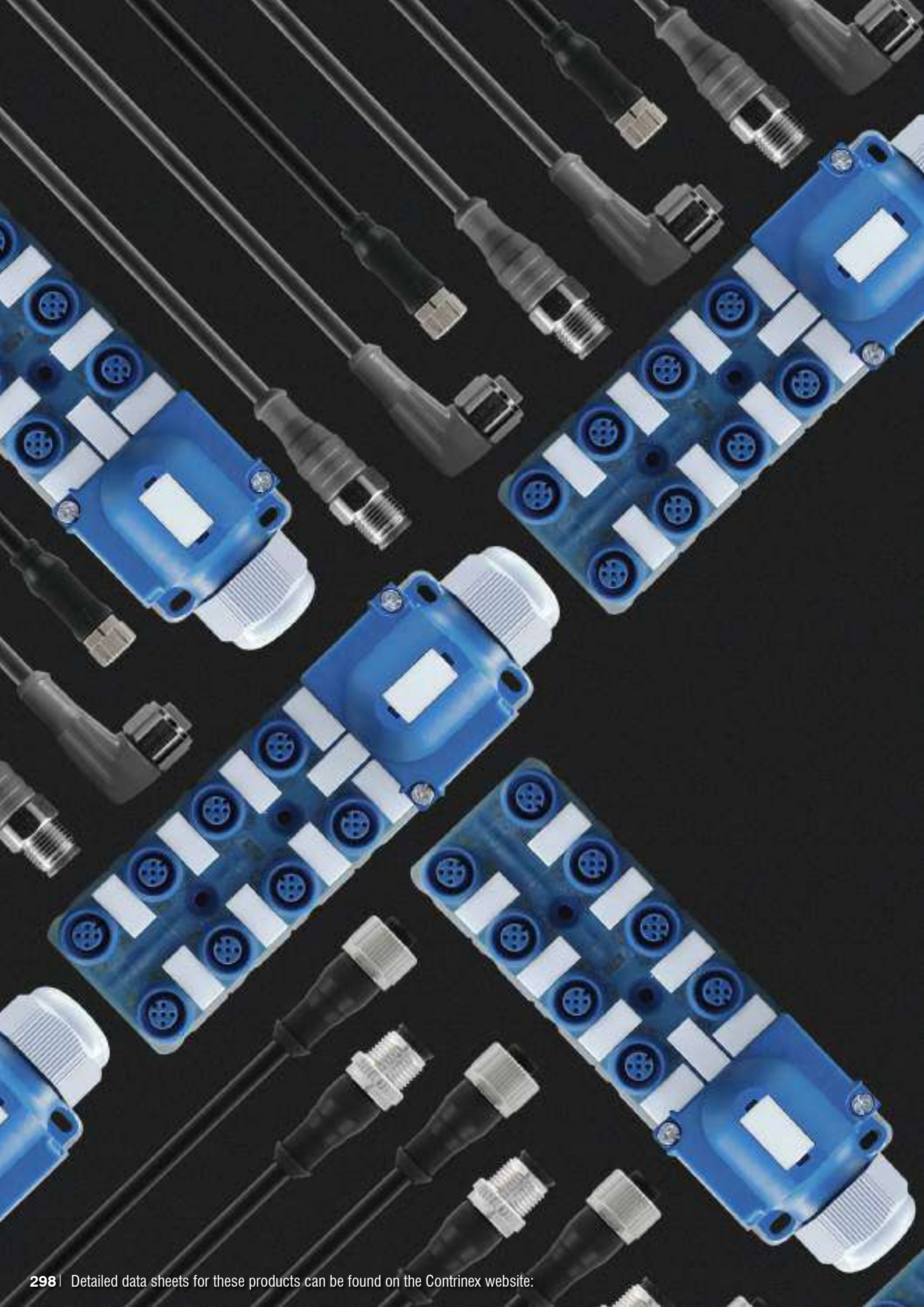



ACCESSORIES

HIGHLIGHTS

- ✓ Comprehensive cable and connector program
- ✓ IP69K and Ecolab-certified cables for the food and beverage industry (on demand)
- ✓ UL-approved cables and connectors
- ✓ Cables with straight or right-angle sockets
- ✓ Distribution boxes
- ✓ Field-attachable connectors
- ✓ T-connectors (on demand)
- ✓ User-friendly standard portfolio
- ✓ Sensor testers for fast field checks
- ✓ Sensor mounting clamps
- ✓ Bases for mounting clamps
- ✓ Mechanical stops
- ✓ Amplifiers for 3-wire and NAMUR sensors (on demand)

INDUCTIVE & PHOTOELECTRIC CABLES

Group A

M8 3-PIN



open ended wire







connecting cables

CONNECTOR	PINS	CONFIG.	CABLE MATERIAL	CABLE LENGTH	WIRE	CABLE CONNECTION END	PINS	PART REFERENCE
M8	3-pole	straight	PUR	2 m	3	OPEN CABLE	–	S08-3FUG-020
M8	3-pole	straight	PUR	5 m	3	OPEN CABLE	–	S08-3FUG-050
M8	3-pole	straight	PUR	10 m	3	OPEN CABLE	–	S08-3FUG-100
M8	3-pole	right angle	PUR	2 m	3	OPEN CABLE	–	S08-3FUW-020
M8	3-pole	right angle	PUR	5 m	3	OPEN CABLE	–	S08-3FUW-050
M8	3-pole	right angle	PUR	10 m	3	OPEN CABLE	–	S08-3FUW-100
M8	3-pole	straight	PVC	2 m	3	OPEN CABLE	–	S08-3FVG-020
M8	3-pole	straight	PVC	5 m	3	OPEN CABLE	–	S08-3FVG-050
M8	3-pole	straight	PVC	10 m	3	OPEN CABLE	–	S08-3FVG-100
M8	3-pole	right angle	PVC	2 m	3	OPEN CABLE	–	S08-3FWW-020
M8	3-pole	right angle	PVC	5 m	3	OPEN CABLE	–	S08-3FWW-050
M8	3-pole	right angle	PVC	10 m	3	OPEN CABLE	–	S08-3FWW-100
M8	3-pole	straight	PUR	0.6 m	–	M8	3	S08-3FUG-006-08MG
M8	3-pole	straight	PUR	2 m	–	M8	3	S08-3FUG-020-08MG
M8	3-pole	straight	PUR	5 m	–	M8	3	S08-3FUG-050-08MG
M8	3-pole	straight	PVC	0.6 m	–	M8	3	S08-3FVG-006-08MG
M8	3-pole	straight	PVC	2 m	–	M8	3	S08-3FVG-020-08MG
M8	3-pole	straight	PVC	5 m	–	M8	3	S08-3FVG-050-08MG











FIELD ATTACHABLE CONNECTORS

CONNECTOR	PINS	CONFIG.	OUTER Ø	WIRE Ø	PART REFERENCE
 M8	3-pole	straight	3.0–5.0	0.08–0.38	S08-3FNG-000-NNT1
 M8	3-pole	straight	4.0–8.0	0.14–0.50	S08-3FNG-000-NNT2
 M8	3-pole	straight	3.0–5.0	0.08–0.38	S08-3MNG-000-NNT1
 M8	3-pole	straight	4.0–8.0	0.14–0.50	S08-3MNG-000-NNT2



DISTRIBUTION BOXES

CONNECTOR	PINS	NUMBER OF CONNECTIONS	CONNECTION TYPE	PART REFERENCE
 M8	3-pole	Universal – Hood	No cable	V08-30PE-000-NNN
 M8	3-pole	10 Plug Distribution box	PUR cable 5 m	V08-31PD-050-UYN
 M8	3-pole	10 Outputs – Hood	PUR cable 5 m	V08-31PH-050-UNN
 M8	3-pole	4 Plug Distribution box	No cable (hood needed)	V08-34PB-000-NYN
 M8	3-pole	4 Plug Distribution box	PUR cable 5 m	V08-34PD-050-UYN
 M8	3-pole	8 Plug Distribution box	No cable (hood needed)	V08-38PB-000-NYN
 M8	3-pole	8 Plug Distribution box	PUR cable 5 m	V08-38PD-050-UYN
 M8	3-pole	8 Outputs – Hood	PUR cable 5 m	V08-38PH-050-UNN



INDUCTIVE & PHOTOELECTRIC CABLES

Group B

M8 4-PIN



open ended wire



connecting cables

CONNECTOR	PINS	CONFIG.	CABLE MATERIAL	CABLE LENGTH	WIRE	CABLE CONNECTION END	PINS	PART REFERENCE
M8	4-pole	straight	PUR	2 m	4	OPEN CABLE	–	S08-4FUG-020
M8	4-pole	straight	PUR	5 m	4	OPEN CABLE	–	S08-4FUG-050
M8	4-pole	straight	PUR	10 m	4	OPEN CABLE	–	S08-4FUG-100
M8	4-pole	right angle	PUR	2 m	4	OPEN CABLE	–	S08-4FUW-020
M8	4-pole	right angle	PUR	5 m	4	OPEN CABLE	–	S08-4FUW-050
M8	4-pole	right angle	PUR	10 m	4	OPEN CABLE	–	S08-4FUW-100
M8	4-pole	straight	PVC	2 m	4	OPEN CABLE	–	S08-4FVG-020
M8	4-pole	straight	PVC	5 m	4	OPEN CABLE	–	S08-4FVG-050
M8	4-pole	straight	PVC	10 m	4	OPEN CABLE	–	S08-4FVG-100
M8	4-pole	right angle	PVC	2 m	4	OPEN CABLE	–	S08-4FVW-020
M8	4-pole	right angle	PVC	5 m	4	OPEN CABLE	–	S08-4FVW-050
M8	4-pole	right angle	PVC	10 m	4	OPEN CABLE	–	S08-4FVW-100
M8	4-pole	straight	PUR	2 m	–	M12	4	S08-4FUG-020-12MG
M8	4-pole	right angle	PUR	2 m	–	M8	4	S08-4FUW-020-08MG
M8	4-pole	straight	PVC	2 m	–	M12	4	S08-4FVG-020-12MG
M8	4-pole	right angle	PVC	2 m	–	M8	4	S08-4FVW-020-08MG



INDUCTIVE & PHOTOELECTRIC CABLES

Group C

M12 4-PIN



open ended wire













connecting cables

CONNECTOR	PINS	CONFIG.	CABLE MATERIAL	CABLE LENGTH	WIRE	CABLE CONNECTION END	PINS	PART REFERENCE
M12	4-pole	straight	PUR	2 m	4	OPEN CABLE	–	S12-4FUG-020
M12	4-pole	straight	PUR	5 m	4	OPEN CABLE	–	S12-4FUG-050
M12	4-pole	straight	PUR	10 m	4	OPEN CABLE	–	S12-4FUG-100
M12	4-pole	straight	PUR	15 m	4	OPEN CABLE	–	S12-4FUG-150
M12	4-pole	straight	PUR	20 m	4	OPEN CABLE	–	S12-4FUG-200
M12	4-pole	straight	PUR	25 m	4	OPEN CABLE	–	S12-4FUG-250
M12	4-pole	right angle	PUR	2 m	4	OPEN CABLE	–	S12-4FUW-020
M12	4-pole	right angle	PUR	5 m	4	OPEN CABLE	–	S12-4FUW-050
M12	4-pole	right angle	PUR	10 m	4	OPEN CABLE	–	S12-4FUW-100
M12	4-pole	right angle	PUR	15 m	4	OPEN CABLE	–	S12-4FUW-150
M12	4-pole	right angle	PUR	20 m	4	OPEN CABLE	–	S12-4FUW-200
M12	4-pole	right angle	PUR	25 m	4	OPEN CABLE	–	S12-4FUW-250
M12	4-pole	straight	PVC	2 m	4	OPEN CABLE	–	S12-4FVG-020
M12	4-pole	straight	PVC	5 m	4	OPEN CABLE	–	S12-4FVG-050
M12	4-pole	straight	PVC	10 m	4	OPEN CABLE	–	S12-4FVG-100
M12	4-pole	right angle	PVC	2 m	4	OPEN CABLE	–	S12-4FVW-020
M12	4-pole	right angle	PVC	5 m	4	OPEN CABLE	–	S12-4FVW-050
M12	4-pole	right angle	PVC	10 m	4	OPEN CABLE	–	S12-4FVW-100
M12	4-pole	straight	PUR	0.6 m	–	M12	4	S12-4FUG-006-12MG
M12	4-pole	straight	PUR	2 m	–	M12	4	S12-4FUG-020-12MG
M12	4-pole	straight	PUR	5 m	–	M12	4	S12-4FUG-050-12MG
M12	4-pole	straight	PVC	0.6 m	–	M12	4	S12-4FVG-006-12MG
M12	4-pole	straight	PVC	2 m	–	M12	4	S12-4FVG-020-12MG
M12	4-pole	straight	PVC	5 m	–	M12	4	S12-4FVG-050-12MG

INDUCTIVE & PHOTOELECTRIC CABLES

Group C

FIELD ATTACHABLE CONNECTORS

CONNECTOR	PINS	CONFIG.	OUTER Ø	WIRE Ø	PART REFERENCE
 M12	3-pole	straight	3.0–5.0	0.08–0.38	S12-3FNG-000-NNT1
 M12	3-pole	straight	3.0–5.0	0.08–0.38	S12-3MNG-000-NNT1
 M12	4-pole	straight	3.0–5.0	0.08–0.38	S12-4FNG-000-NNT1
 M12	4-pole	straight	4.0–8.0	0.14–0.50	S12-4FNG-000-NNT2
 M12	4-pole	straight	5.5–8.0	0.50–1.00	S12-4FNG-000-NNT3
 M12	4-pole	right angle	3.0–5.0	0.08–0.38	S12-4FNW-000-NNT1
 M12	4-pole	straight	3.0–5.0	0.08–0.38	S12-4MNG-000-NNT1
 M12	4-pole	straight	4.0–8.0	0.14–0.50	S12-4MNG-000-NNT2
 M12	4-pole	straight	5.5–8.0	0.50–1.00	S12-4MNG-000-NNT3
 M12	4-pole	right angle	3.0–5.0	0.08–0.38	S12-4MNW-000-NNT1





DISTRIBUTION BOXES

CONNECTOR	PINS	NUMBER OF CONNECTIONS	CONNECTION TYPE	PART REFERENCE
 M12	5-pole	Universal – Hood	No cable	V12-50PE-000-NNN
 M12	5-pole	4 Plug Distribution box	Connector M23	V12-54MG-023-NYN
 M12	5-pole	4 Plug Distribution box	No cable (hood needed)	V12-54PB-000-NYN
 M12	5-pole	4 Plug Distribution box	PUR cable 2 m	V12-54PD-020-UYN
 M12	5-pole	4 Plug Distribution box	PUR cable 5 m	V12-54PD-050-UYN
 M12	5-pole	4 Plug Distribution box	PUR cable 10 m	V12-54PD-100-UYN
 M12	5-pole	4 Plug Distribution box + Hood	PUR cable 5 m	V12-54PY-050-UYN
 M12	5-pole	8 Plug Metal Distribution box	PUR cable 5 m	V12-58MD-050-UYN
 M12	5-pole	8 Plug Metal Distribution box	PUR cable 10 m	V12-58MD-100-UYN
 M12	5-pole	8 Plug Metal Distribution box	Connector M23	V12-58MG-023-NYN
 M12	5-pole	8 Plug Distribution box	No cable (hood needed)	V12-58PB-000-NYN
 M12	5-pole	8 Plug Distribution box	PUR cable 2 m	V12-58PD-020-UYN
 M12	5-pole	8 Plug Distribution box	PUR cable 5 m	V12-58PD-050-UYN
 M12	5-pole	8 Plug Distribution box	PUR cable 10 m	V12-58PD-100-UYN
 M12	5-pole	8 Plug Distribution box + Hood	PUR cable 2 m	V12-58PY-020-UYN
 M12	5-pole	8 Plug Distribution box + Hood	PUR cable 5 m	V12-58PY-050-UYN







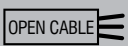

INDUCTIVE & PHOTOELECTRIC CABLES

Group D

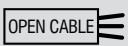
M12 AC/DC 3-PIN

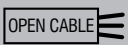

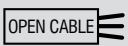
CONNECTOR	PINS	CONFIG.	CABLE MATERIAL	CABLE LENGTH	WIRE	CABLE CONNECTION END	PINS	PART REFERENCE
 UNF 1/2"	3	straight	PUR	2 m	3		–	S13-3FUG-020
 UNF 1/2"	3	straight	PUR	5 m	3		–	S13-3FUG-050
 UNF 1/2"	3	right angle	PUR	2 m	3		–	S13-3FUW-020
 UNF 1/2"	3	right angle	PUR	5 m	3		–	S13-3FUW-050



UNIVERSAL MOUNTING BRACKETS

Group E

UNIVERSAL MOUNTING BRACKETS

	HOUSING SIZE COMPATIBILITY	TYPE	PART REFERENCE
	Ø 3	without limit stop	ASU-0001-030
	Ø 4	without limit stop	ASU-0001-040
	Ø 5	without limit stop	ASU-0001-050
	Ø 6.5	without limit stop	ASU-0001-065
	Ø 8	without limit stop	ASU-0001-080
	Ø 8	with limit stop	ASU-0002-080
	Ø 12 mm	without limit stop	ASU-0001-120
	Ø 12 mm	with limit stop	ASU-0002-120
	Ø 18 mm	without limit stop	ASU-0001-180
	Ø 18 mm	with limit stop	ASU-0002-180

MECHANICAL STOPS

	INNER Ø	OUTER Ø	PLUNGER TYPE	MAX. FORCE ON HOUSING	MAX. FORCE ON PLUNGER	PART REFERENCE
	M5 × 0.5	M8 × 1	Flat ¹	8,000 N	2,000 N	AMS-0001-M08
	M5 × 0.5	M8 × 1	Spherical ²	8,000 N	2,000 N	AMS-0002-M08
	M8 × 1	M12 × 1	Flat ¹	15,000 N	2,000 N	AMS-0001-M12
	M8 × 1	M12 × 1	Spherical ²	15,000 N	2,000 N	AMS-0002-M12

Material: Steel XC 48, black
Max. tightening torque: 30 Nm (M8), 50 Nm (M12)

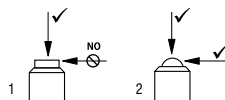

PHOTOELECTRIC MOUNTING BRACKETS

Group F

	HOUSING SIZE COMPATIBILITY	BRACKET MATERIAL	PART REFERENCE
	C23PA series	Stainless steel V2A	LXW-C23PA-000
	C23PA series	Stainless steel V2A	LXW-C23PA-001
	C23PA series	Stainless steel V2A	LXW-C23PA-002
	C23PA series	Stainless steel V2A	LXW-C23PA-003
	DGI series MGI series	Stainless steel V2A	LXW-DGMGA-000











	HOUSING SIZE COMPATIBILITY	BRACKET MATERIAL	PART REFERENCE
	M18PA series	ABS/PMMA	LHW-M18PA-000
	M18PA series	ABS/PMMA	LLW-M18PA-000
	M18PA series	ABS/PMMA	LTW-M18PA-000
	M18PA series	ABS	LXW-M18PA-000
	M18PA series	Polyamide	LXW-M18PA-001

PHOTOELECTRIC REFLECTORS

Group G

REFLECTORS

	DIMENSIONS	PART REFERENCE
	Ø26 mm	LXR-0000-025
	Ø46 mm	LXR-0000-046
	Ø82 mm	LXR-0000-084
	32 × 20 mm	LXR-0001-032
	60 × 20 mm	LXR-0001-062
	Ø26 mm	LXU-0000-025
	Ø82 mm	LXU-0000-084
	32 × 20 mm	LXU-0001-032
	60 × 41 mm	LXU-0001-064



SENSOR TESTER

Group H

	PART REFERENCE
	ATE-0000-010

ACCESSORIES REFERENCE KEY

CABLES / CONNECTORS

S12-4FAG-020[-NNLN-12MG]

CONNECTION CABLE

S

CONNECTOR SIZE FEMALE

M8	08
M12	12
M12 AC/DC	13
M23	23

NUMBER OF POLES

3-pole	3
4-pole	4
5-pole	5
8-pole	8
11-pole	B
19-pole	J

CONNECTOR TYPE

Female (socket)	F
Male (plug)	M

CABLE MATERIAL

No cable	N
PVC	V
PUR	U
TPE-S	A

CABLE EXIT (FEMALE)

Straight	G
Right-angle	W

CABLE LENGTH

No cable	000
0.3 m	003
0.6 m	006
1 m	010
1.5 m	015
2 m (standard)	020
5 m	050
10 m	100
15 m	150
20 m	200
25 m	250

CABLE EXIT (MALE)

Straight	G
Right-angle	W

CONNECTOR TYPE

Male (plug)	M
Female (socket)	F

CONNECTOR SIZE MALE

M8	08
M12	12
M23	23

CONNECTION TYPE

Standard	N
Quick-lock	Q
Cable Ø 3.0–5.0 mm / wire 0.08–0.38 mm ²	1
Cable Ø 4.0–8.0 mm / wire 0.14–0.50 mm ²	2
Cable Ø 5.5–8.0 mm / wire 0.5–1.0 mm ²	3

APPLICATION

Standard	N
Food	L
RFID	R
Field attachable	T
Safety	S

EXECUTION

Standard or no cable	N
Shielded	W

LED

Yes, PNP	Y
Yes, NPN	Z
No	N



DISTRIBUTION BOXES AND T-CONNECTORS

V12-58PD-050-UYN (-###)

DISTRIBUTION BOX OR T-CONNECTOR	V
--	----------

CONNECTIONS	
Accessory	00
M8	08
M12	12

POLE NUMBER OF CONNECTIONS	
3-pole	3
4-pole	4
5-pole	5
8-pole	8

NUMBER OF CONNECTIONS	
Hood for all types	0
2 connections	T
4 connections	4
6 connections	6
8 connections	8
10 connections	1

MATERIAL	
Plastic	P
Metal	M

TYPE	
Distribution box with cable / T-connector	D
Distribution box for straight connection	G
Distribution box for right-angle connection	W
Base element without hood	B
Hood with cable	H
Hood without cable	E
Base element + hood with cable	Y

SPECIAL EXECUTIONS	
---------------------------	--

TECHNOLOGY	
Standard (passive distribution box)	N
Wiring according diagram no.	#

LED	
Yes	Y
No	N

CABLE MATERIAL	
No cable	N
PVC	V
PUR	U

CONNECTION	
No cable	000
Cable 0.3 m	003
Cable 2 m	020
Cable 5 m	050
Cable 10 m	100
Connector M12	012
Connector M23	023

ACCESSORIES REFERENCE KEY

MISCELLANEOUS

APT-0001-010

ACCESSORY A

ACCESSORY TYPE

Mechanical stop	MS
Protective tube	PT
Tester	TE

MATERIAL

Protective tubes, Tester	
Material PTFE, spiral, split	000

DIMENSIONS

Mechanical stops	
Outer diameter M08=M8 × 1 thread	M08
Outer diameter M12=M12 × 1 thread	M12
Protective tubes	
Length in dm (1 m)	010
Length in dm (10 m)	100

SERIES

Mechanical stops	
Flat plunger	1
Spheric plunger	2
Protective tubes	
Inner Ø3.5 mm / Outer Ø6.0 mm	0
Inner Ø6.5 mm / Outer Ø10.0 mm	1
Inner Ø13.0 mm / Outer Ø17.5 mm	2
Inner Ø19.0 mm / Outer Ø23.5 mm	3
Tester	
Base	0

PHOTOELECTRIC MOUNTING BRACKETS AND SPECIAL MOUNTINGS

LXW-C23PA-000

PHOTOELECTRIC SENSOR L

SENSOR TYPE

With background suppression	H
Through-beam sensor	L
Diffuse sensor	T
Accessories	X

DEVICE TYPE

Mounting bracket	W
------------------	---

HOUSING SIZE COMPATIBILITY

C23PA series	C23PA
DGI, MGI series	DGM
M18PA series	M18PA

INCREMENTAL NUMBER

Incremental number	000
Incremental number	001
Incremental number	002
Incremental number	003

PERFORMANCE

Standard	A, B
----------	------

HOUSING MATERIAL

Stainless steel V4A	G
Plastic	P



MOUNTING BRACKETS

ASU-0001-030

ACCESSORY **A**

ACCESSORY TYPE	
Mounting brackets	SU

FIXTURE	
Standard Basic fixture	00
Standard Cylindrical fixture	30

MATERIAL	
Plastic	0
Stainless steel V2A	1
Coated steel	4

DIMENSIONS

Ø 3 mm	030
Ø 4 mm	040
Ø 5 mm	050
Ø 6.5 mm	065
Ø 8 mm	080
Ø 12 mm	120
Ø 18 mm	180
Ø 30 mm	300

TYPE

Without limit stop	1
With limit stop	2
For C44	3
For 4#5#	4
For C1717	5

PHOTOELECTRIC REFLECTORS

LXR-0000-025

PHOTOELECTRIC SENSOR **L**

SENSOR TYPE	
Accessories	X

DEVICE TYPE	
Reflector	R
Reflector for UV	U

SHAPE	
Cylindrical reflector	0000
Rectangular reflector	0001

DIMENSIONS

Cylindrical reflectors	
Ø 26 mm	025
Ø 46 mm	046
Ø 82 mm	084
Rectangular reflectors	
32 × 20 mm	032
60 × 20 mm	062
60 × 41 mm	064



ALL OVER THE WORLD

EUROPE

Austria
Belgium
Croatia
Czech Republic
Denmark
Estonia
Finland
France*
Germany*
Great Britain
Greece
Hungary
Ireland
Italy*
Luxembourg
Netherlands
Norway
Poland
Portugal*
Romania
Russian Federation

Serbia
Slovakia
Slovenia
Spain
Sweden
Switzerland*
Turkey
Ukraine

AFRICA

Morocco
South Africa

THE AMERICAS

Argentina
Brazil*
Canada
Chile
Mexico*
Peru
United States*

ASIA

China*
India*
Indonesia
Japan*
Korea
Malaysia
Pakistan
Philippines
Singapore
Taiwan
Thailand

AUSTRALASIA

Australia
New Zealand

MIDDLE EAST

Israel
United Arab Emirates

Terms of delivery and right to change design reserved.

*Contrinex subsidiary

HEADQUARTERS

CONTRINEX AG Industrial Electronics
Route du Pâqui 3 – PO Box – CH-1720 Corminboeuf – Switzerland
Tel: +41 26 460 46 46 – Fax: +41 26 460 46 40
Internet: www.contrinex.com – E-mail: info@contrinex.com



www.contrinex.com

PLUS+AUTOMATION
HELPING YOU #MAKESENSEOFSENSORS

0121 58 222 58
Sales@PLUSAutomation.co.uk
www.PLUSAutomation.co.uk



© **CONTRINEX AG 2022**
900-307-002 – KAY – 08.22 – 500